

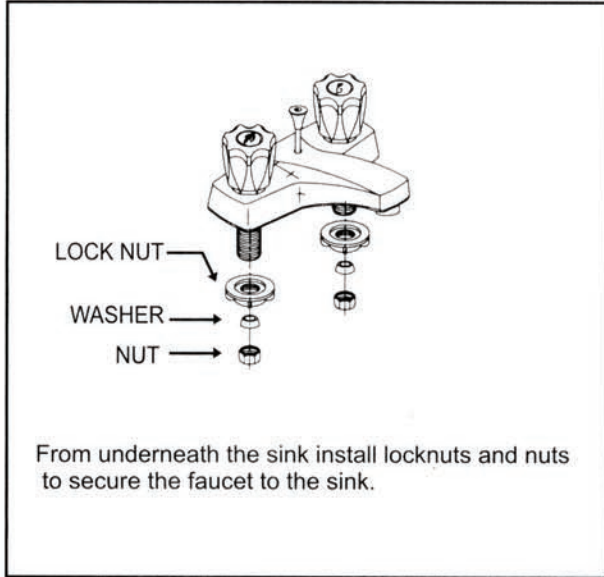

DOMINION FAUCETS

Installation Instructions Two Handle Lavatory 4" Center Set

STEP1



STEP2

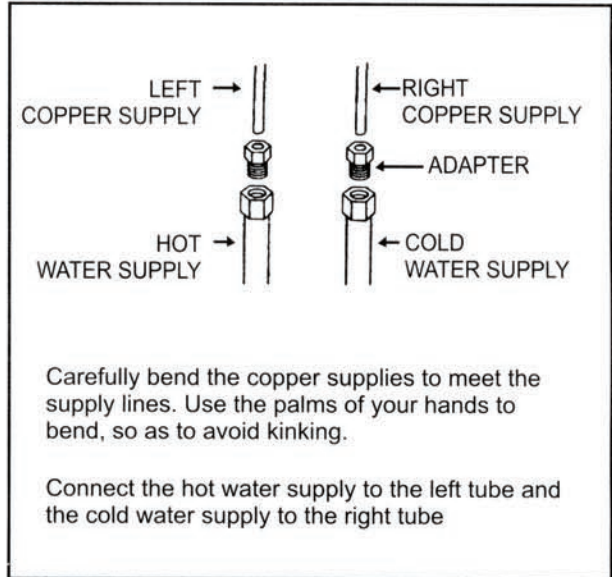

STEP3

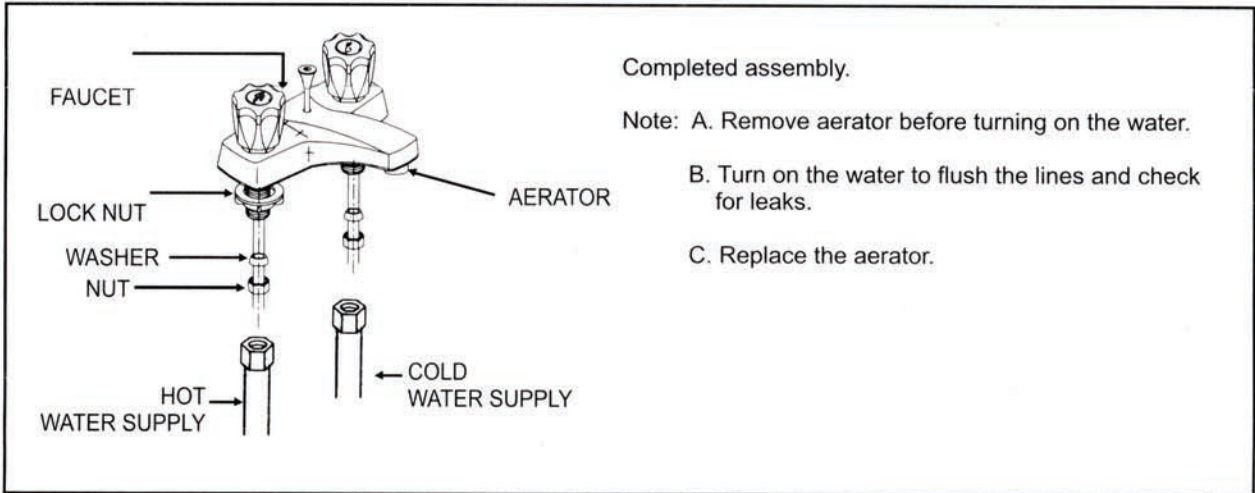



DOMINION FAUCETS

Installation Instructions Two Handle Lavatory 4" Center Set

STEP 4

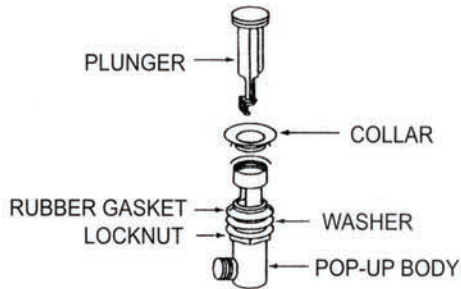

Remove collar and plunger from pop-up body. Turn locknut down as far as it will go and install washer and rubber gasket.

Place a bead of plumbers putty on underside of collar before inserting it into drain hole. Screw pop-up body into collar from under sink.

STEP 5

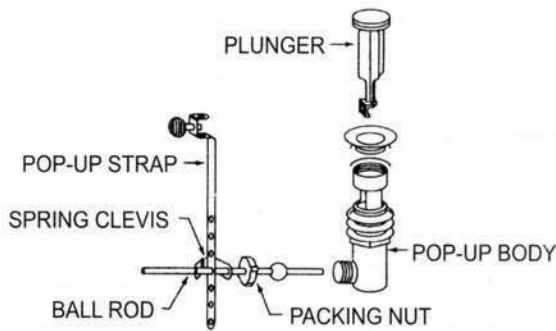

Place plunger into pop-up body and slide ball rod into plunger hole. Secure ball rod to pop-up body with packing nut.

Place pop-up strap and spring clevis over ball rod as shown.

STEP 6

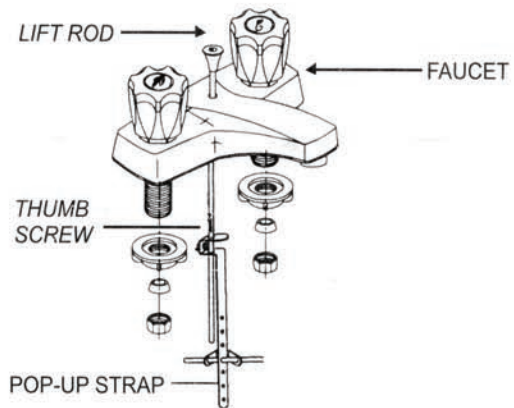

Insert lift rod down faucet hole and into holes of pop-up strap. Adjust and tighten thumb screw to obtain proper operation.

STEP 7

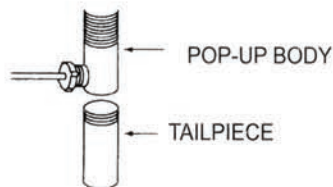

Put pipe compound on tailpiece and thread into pop-up body hand tight.

Hook up drain trap ass'y to tail piece per local plumbing codes. Turn on water and test for leaks.

ASSEMBLY

